

als



airfield lighting systems

Big enough to cope,
small enough to care.



ICAO • Annex 14 Volume I
 EASA • CS-ADR-DSN
 IEC • TS 61827
 AENA • DIN/DSEYN/PPT/019

FAA • AC 150/5345-46
 • EB No. 67

Compliant with NATO, UK
 & US Military Specifications

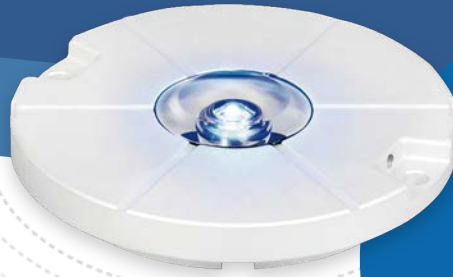

als



8" LED Inset Lights

- TE/IN-B Taxiway Edge
- TE/IN-Y Aircraft Stand Manoeuvring Guidance

FEATURES

- Low protrusion of 6 mm above ground level
- Adaptable to all kinds of CCRs and ILCMS systems
- PWM digital regulation providing excellent consistency of chromaticity
- Aluminum alloy forged top cover with hardened surface and corrosion resistance treatment
- Built-in surge protection
- Specially designed fail open system suitable for strong magnetism, vibration and other environments

TECHNICAL DATA



MECHANICAL

Mounting • 2 x M10 bolts Static Load Resistance • $\geq 18t$ Net Weight • 3.5kg Gross Weight • 3.7kg
 Packing Dimensions • 253mm (L) x 223mm (W) x 107mm (H)



ENVIRONMENTAL

Operating Temperature • - 55°C~+55°C Storage Temperature • - 55°C~+85°C Protection Class • IP68 Humidity • 0~100%



ELECTRICAL

Connection • FAA L-823 Rated Input Current • 6.6A/2.2A Power Consumption • 8VA
 Power Factor • > 0.98 Immunity • IEC 61000-6-2 Emission • IEC 61000-6-4
 Service Life • LED useful lamp life > 80000h





COMPONENTS

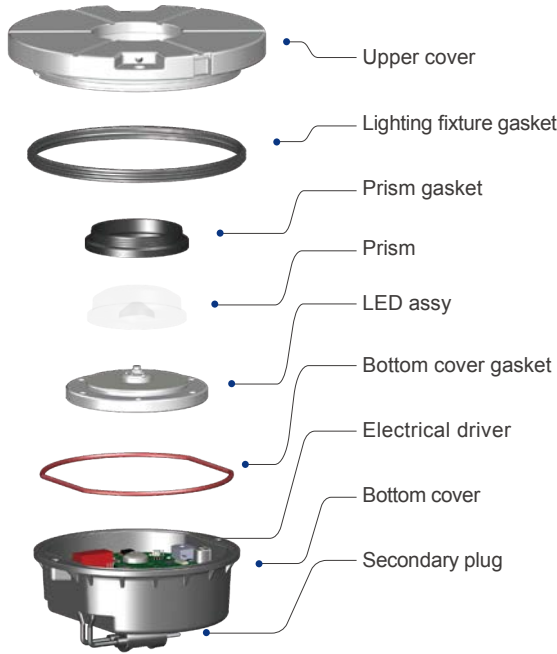

DIMENSIONS

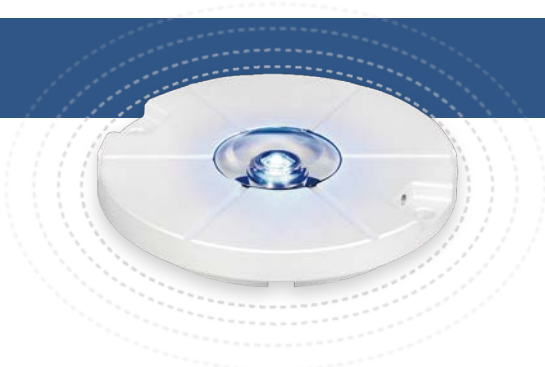
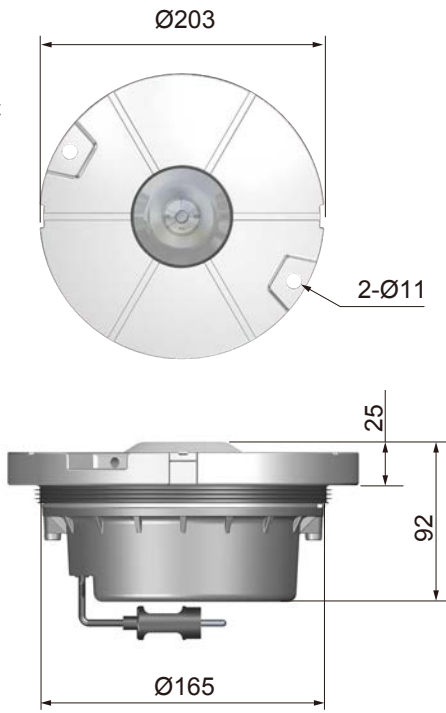

ACCESSORIES

- ◎ 8 inches shallow base assy (bottom entry/side entry)
- ◎ 12 inches shallow base assy (bottom entry/side entry)
- ◎ 12 inches deep base assy
- ◎ 8-12 inches adapter ring assy
- ◎ L-823 receptacle
- ◎ 8 inches light fixture handle

PHOTOMETRICS

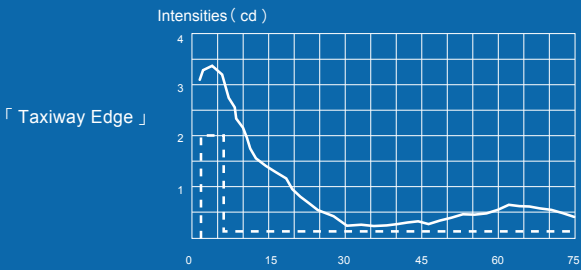

Color: Blue
 Required - - - -
 Measured ———

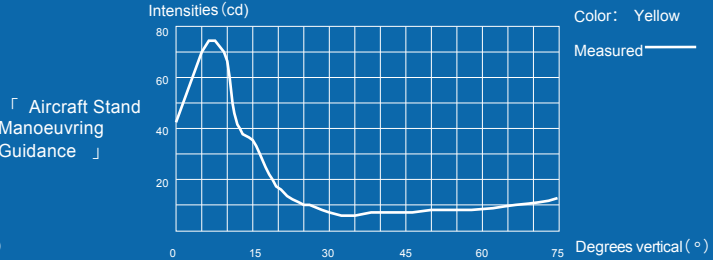

Color: Yellow
 Measured ———



Airfield Lighting Systems UK Limited (Headquarters)

Head Office: Aviation House, Russell Gardens, Wickford, Essex, SS11 8BF

Tel: +44 1702 547562

ALS MENASA Trading FZCo

Address: JAFZA One Tower A - Floor 6 - Office 610 - Mina Jebel Ali - Jebel Ali Freezone - Dubai - United Arab Emirates

Tel:+44 1702 547562 ex 218

Website: www.airfieldlightingsystems.com
 Email: sales@airfieldlightingsystems.com

ORDERING CODES

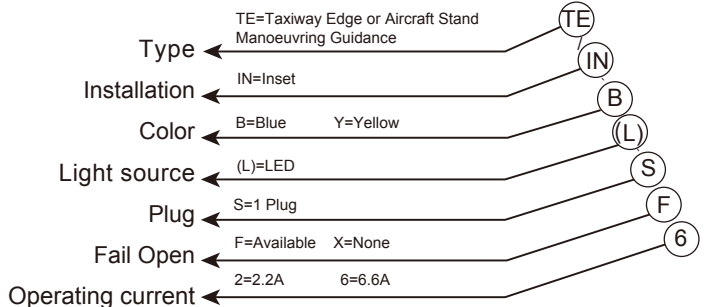

* Accessories should be ordered separately